

**PREINSTALLATION
VORINSTALLATION**

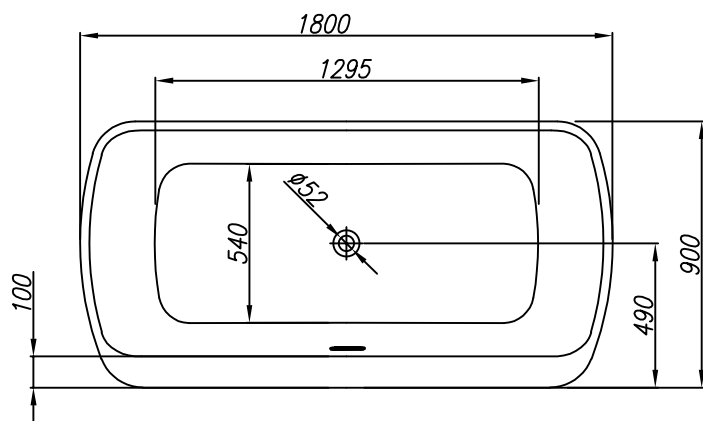
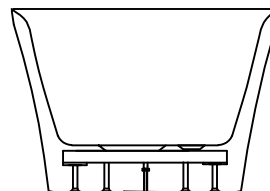
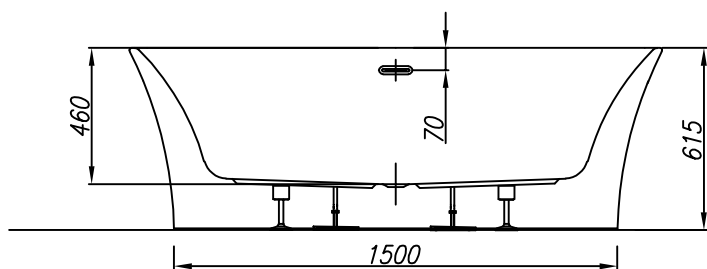

VOLUME (l)
VOLUMEN (l)

MAX. LOAD (kg)
MAX. BELASTUNG (kg)

FLOOR LOAD (kg/m²)
BODENBELASTUNG (kg/m²)

260

420

280

- - Spot for el. cable 3×2.5mm², length approx. 1m
- Platz Stromkabel 3 × 2,5 mm², Länge cca. 1 m
- - Spot for el. cable 1×6mm² for earthing, length approx. 1.5m
- Platz Stromkabel 1 × 6 mm² für Erdung, Länge cca. 1,5 m

- ⚡ - Connection of hot and cold water 1/2" min 0.2Mpa, max 0.4Mpa
- Anschluss Warm- und Kaltwasser 1/2" min 0,2 Mpa, max 0,4 Mpa

- - Drain spot Ø 50mm
- Abflussplatz Ø 50 mm
- ▨ - Panel - option
- Möglichkeit - Schürze

**INSTALLATION RECOMMENDATION
MONTAGEEMPFEHLUNG**

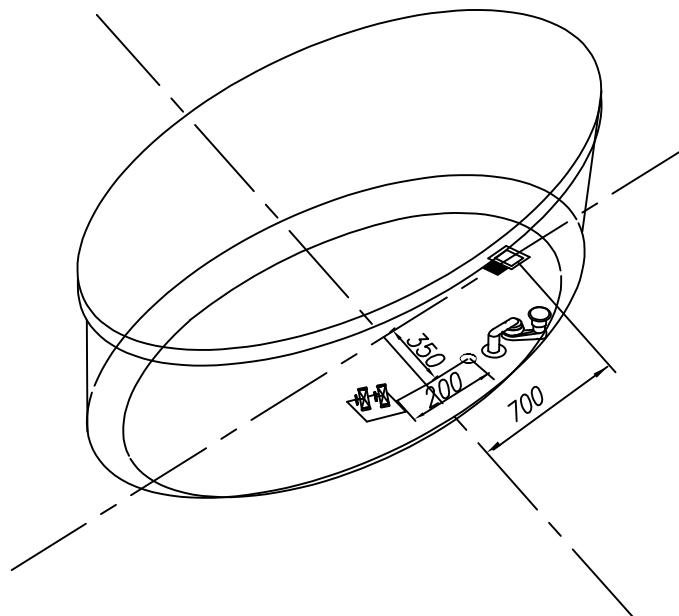

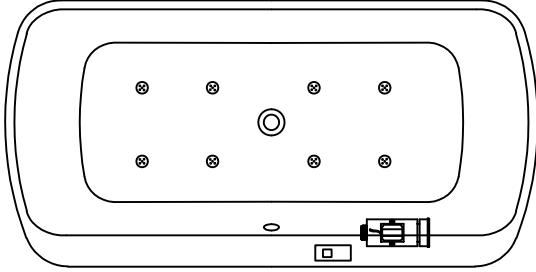
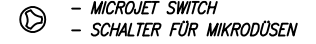
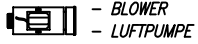
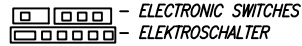
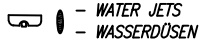
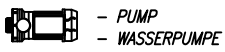

AIR MASSAGE SYSTEM

- BLOWER P=800W
- ELECTRONIC SWITCH
- 8 AIR JETS

LUFT MASSAGESYSTEM

- LUFTPUMPE P = 800 W
- ELEKTROSCHALTER
- 8 LUFTDÜSEN

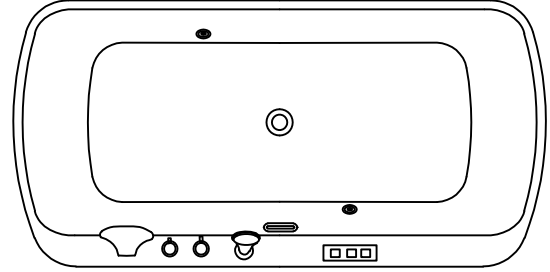

- OPTION FIXTURE AND SHOWER HANDLE
- MÖGLICHKEIT WASSERHAHN UND DUSCHE

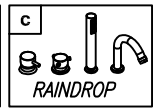
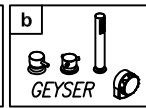
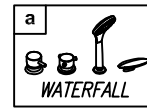
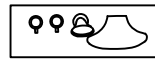

- OPTION CHROMOTHERAPY



- MÖGLICHKEIT CHROMOTHERAPIE